



My Video Player

VP320 / VP330



**Lecteur Audio / Vidéo
4K UHD - HDR**

USER MANUAL

SOMMAIRE

A - Safety instructions.....	P1
B - Product information.....	P3
1 - Product presentation	P4
2 - Main functionalities.....	P4
3 - Installation	P5
4 - Operating mode.....	P10
5 - Timestamped Programming control (Scheduler).....	P20
6 - RS232 serial link protocol.....	P22
7 - Ethernet.....	P26
8 - Menu	P27
Annexe A : Characteristics.....	P30
Annexe B : Infrared remote control.....	P33
Annexe C : Mapping input / folder	P34
Annexe D : Accessories.....	P35
Annexe E : Frequently questions.....	P36

ID-AL products are exclusively manufactured by Waves System

LA VILLE EN BOIS - 44830 BOUAYE - FRANCE

Sales and information: +33 2 40 78 22 44

E-mail : info@id-al.com - Web site: <http://www.id-al.com>

Technical department : support@wssystem.com

Technical support :

For a detailed list of the technical support options, we suggest you to visit our site www.id-al.com.

Information in this manual is subject to change without notice and do not represent any commitment from Waves System. The equipment described in this manual is supplied under condition of the terms of license specifying the legal use conditions. This manual can't be reproduced or used, in whole or in part, in any form and by any mean, for other use than private, without the written permission from Waves System.

ID-AL is a trademarks of Waves System.

CAUTION! DO NOT EXPOSE TO HUMIDITY & DUST!

Unplug the power supply cable before any servicing

FOR YOUR SAFETY, PLEASE READ THE USER'S GUIDE CAREFULLY BEFORE OPERATING YOUR PLAYER.

A. SAFETY INSTRUCTIONS

A.1 CE marking

The CE marking is found on the nameplate, at the rear side of the device. It certifies the conformance of the device with the low voltage CE Directive, according to the EN 55022 standard, and the Electromagnetic Compatibility Directive 61000-4-x.

A.2 Directives

- The requirements related to the electromagnetic compatibility and low voltages directive are met.

A.3 Overview

- The user manual is an integral part of the product. It must always be kept handy & close by. Proper usage conforming to the product intended purpose involves strict compliance with the instructions given in this manual.

In the event of return of the equipment, the user manual should be handed over to the new purchaser. The staff should receive instructions concerning the proper usage of the device.

- Only usage of genuine parts ensures perfect safety for the user and correct operation of the device. Moreover, only accessories mentioned in the technical documentation or explicitly approved by the manufacturer must be used. In the event of usage of accessories or consumable products from other brands, the manufacturer cannot stand guarantee for the correct and safe operation of the device.

- Damages caused through usage of accessories or consumable products from other brands will not entail right to any benefit under the terms of warranty.

- The manufacturer will be liable for the safety, reliability and functioning of the product as long as the assembly, settings, modifications, extensions and repairs have been carried out by the manufacturer or a company approved by the manufacturer and if the device is used in accordance with the instructions mentioned in this manual.

- The player complies with the technical safety standards in force at the date of print of this manual. All rights reserved for the electrical diagrams, procedures, names and devices mentioned herein.

- Any reproduction of the technical documentation, even partially, without the written authorization from Waves System is prohibited.

A.4 General Safety instructions

This device has been shipped out from our facilities in perfect working condition. In order to preserve these conditions, for safety and to avoid any risk of accidental bodily injury, the user must imperatively follow the safety instructions and read the 'Caution!' messages included in this manual.

This device, made by Waves System, has been designed in a way that practically eliminates any risk if it is used in accordance to its intended purpose. Nevertheless, with a concern for safety, we would like to draw your attention to the following instructions:

- When using the device, comply with all local rules and regulations in force. Any modification or conversion of the device automatically entails loss of the homologation. The operation of a modified device is liable to a penalty. In the interest of occupational safety, the operator and the user are held responsible for complying with the regulations.
- Keep the original packing for a possible product re-shipment. Also ensure to keep the packing material out of children's reach. Only this original packing ensures optimal protection for the product during transportation. If a product reshipment appears to be necessary during the guarantee period, Waves System is not liable for any ensuing damages arising during the transportation and attributable to a defective packing.
- This device is used to broadcast video and audio files. It should be used only by persons whose training or knowledge ensures proper handling.
- Before every use, the operator must check that the device is in perfect working condition.
- This product must not be used in places where there is a potential explosion risk. Besides, it must neither be used in an environment favouring combustion nor in a humid or excessively hot or cold location.

A.5 Safety instructions against risks due to electric currents

- The device must be connected to a grounded AC power outlet or a European standard outlet installed as per good professional practices.
- Before connecting the device, check that the power supply voltage and frequency match the specifications indicated on the device.
- Before powering, check that the device and cables are not damaged. Damaged cables and connections must immediately be replaced.
- Never allow the power cords to come in contact with other cables. Handle the power supply cable as well as all other cables connected to the mains with extreme care.
- Always connect the plug-in connector in the end. Ensure that the On/Off switch is in 'Off' position before connecting the device to the mains. The mains outlet must remain accessible after the installation.
- Check the device and its power supply cable from time to time. Disconnect the device from the mains when it is no longer used or for the purpose of maintenance.
- Handle the power cord by using the plug-in connector only. Never remove the plug-in connector by pulling the power cord.
- Electrical connection, repairs and maintenance must be carried out by qualified personnel.
- Do not switch on or switch off the device within a short span of time as this will reduce equipment life.

A.6 - Terms of use:

- This product has been designed for indoors use only.
- If this device has been exposed to very high temperature fluctuations (e.g.: after transportation), do not connect it immediately. The condensation formed inside the device could damage it. Allow the device to attain ambient temperature before connecting it.
- Do not shake the device, avoid sudden movements during its installation or handling.
- When selecting the spot for installation of the player, ensure that it is not exposed to a high source of heat, humidity or dust. There should not be any cables lying around as they might jeopardise your & others safety.

B. PRODUCT INFORMATION

B.1 Correct usage

The player is used to broadcast audio/video files automatically.
Correct usage involves compliance with the instructions given in this manual as well as with the requirements concerning installation.

B.2 Incorrect usage

Any other usage or usage beyond the scope of this application is considered as incorrect usage. The manufacturer shall not be liable for the damages ensuing from it. The user shall bear full responsibility for the risks incurred.

B.3 Delivery details

VideoPlayer VP320 or VP330
External power supply and its power supply cable
Remote control
User's manual

B.4 Specifications

Audio/video Player model : VP320 or VP330
Nominal electrical values of the power supply connection
Voltage (V) 100 to 240
Frequency (Hz) 50-60
For details see Annexe B

B.5 Installation

The device must be installed in a dust free area.

Do not install the device directly against a wall. To avoid overheating, the ventilation openings must not be blocked. Take care to leave an empty space above the ventilation slits.

B.6 Electrical connection

Before activation, check whether the mains voltage matches with the voltage indicated on the rating plate.

1 - Product presentation

The My Video Player VP3x0 are interactive full HD video player. The files are stored on a USB device or MicroSD or internal flash memory. This standalone player can read files automatically after power on: Autoplay function.

The VP330 version offer 8 inputs and 8 outputs of contacts to control the player and control external device like LEDs, motors, relays...

VP3x0 are used in digital signage market or integration projects for museums, exhibitions, retail, theme parks & tourist attractions...

2 - Main fonctionnalités

Interactivity: VP3x0 are interactive player that reacts according to events.

- Playback pattern is defined by the name of the files or the folders
- Electrical contacts: 1 input to trigger files through sensors, push-buttons, relays ...
- Infrared sensor allows the use of a remote control.

VP330 offer extended functions:

- 8 inputs + 8 outputs electric contacts
- Commands through the RS232 serial link. A simple protocol is used to send instructions to the player.
- 5V power output.

Autoplay: VP3x0 starts automatically on powering on. This function is configurable and can be disabled.

Playback: The audio files stored on the media can be organized in a particular way to define playback pattern. The playback pattern is defined by the names of the files and the folders, allowing a wide flexibility of use.

Ethernet : Use this link to update the files on the medias from your network.

Serial link RS232: VP330 can be controlled by a PLC, a computer, a remote control using a serial link. VP330 receives data on its Rx input and sends datas on its Tx output. A specific protocol is described in this manual.

3 - Installation

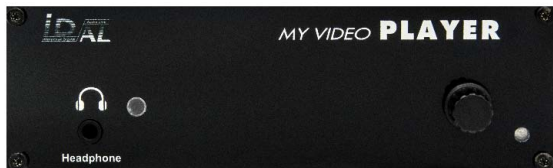

- 1 - Headphone audio output
- 2 - Infrared sensor
- 3 - Volume
- 4 - Activity LED



VP330



- 5 - Analog audio output
- 6 - Amplified speaker output
- 7 - USB 1
- 8 - Input contact
- 9 - Video/audio HDMI output / Micro SD
- 10 - Ethernet connector
- 11 - USB 2
- 12 - Power supply input

VP320



- Version VP330 uniquement :**
- 13 - RS232 link
 - 14 - 8 input contacts
 - 15 - 8 output contacts
 - 16 - 5V power supply output

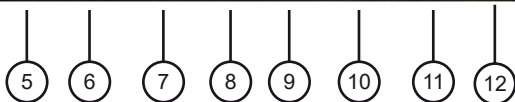

First use: VP3x0 are factory setting configured with parameters by default and the player must operate on inserting a prepared media dedicated to (chapter 4).

1 - Insert a prepared USB flash memory.



USB flash memory

2 - Connect a display, speakers or a sound system to the audio output and switch on the player thanks to the PSU

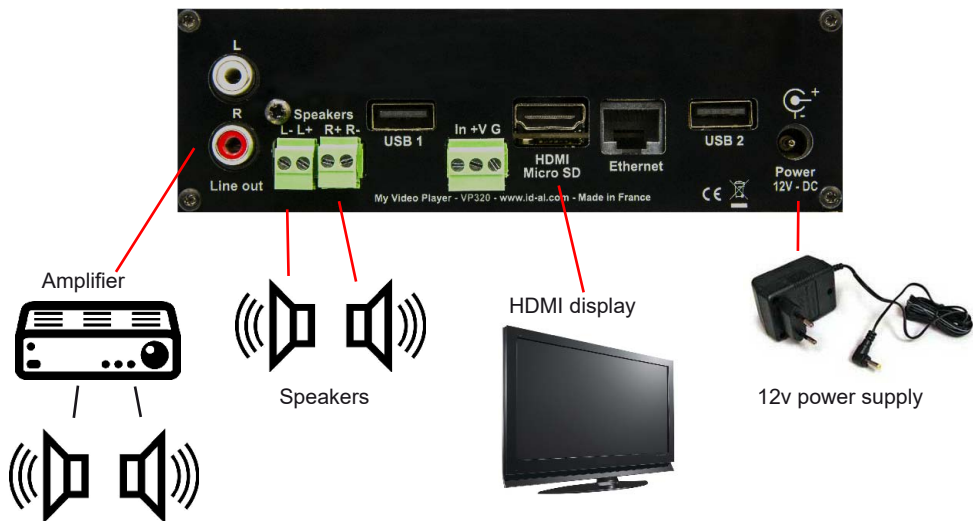

Power Supply Unit: We recommend you to use the PSU provided with the player. If you use another PSU, you have to respect the 12V specified voltage although the player can be power supplied between 10V and 15V. The power consumed depends on the power level of the amplifier.

Preparation of the medias:

Brand new USB flash drive are usually «FAT32» formatted.

If you must format a stick, select the FAT32 format according to the memory size. If the size of the files are over 4GB, select NTFS format. Other types of formatting do not work.

If you use Windows PC computer, latest versions do not allow to format high capacity medias (>32Go) system FAT32. In this case you must obtain a formatting software. Many softwares are available, some free, others payable that you will easily find on internet.

3.1 - Connections

Connection is directly from the sensor/push button to the player trigger input.

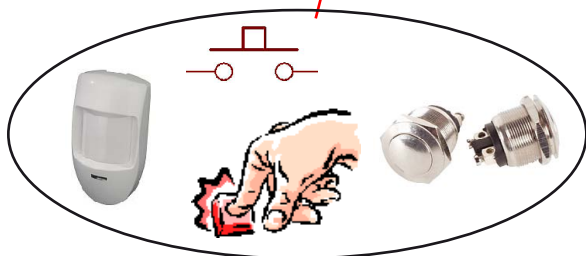

Internal input schematic

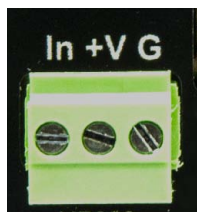
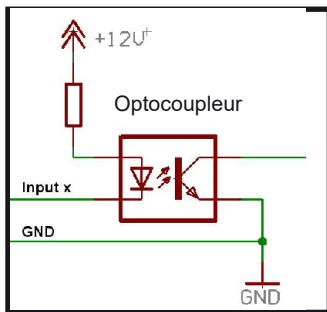

- In - Trigger input
- +V - power supply output for an external peripheral device
- G - Ground

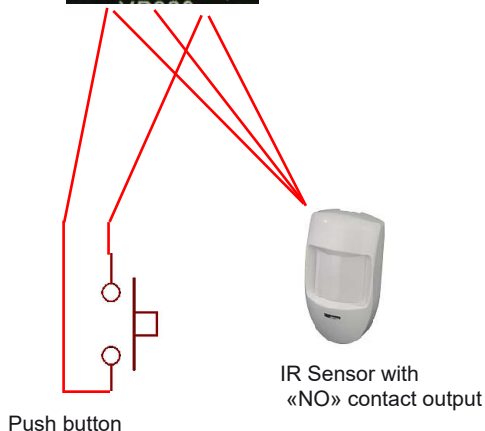

Note: +12v is a transfer of the main external PSU. The provided power will not exceed 500mA.

3.2 - Connexions - 8 input - VP330 only

Up to 8 inputs, the connections are direct. Over 8 inputs, you need to make a combination using diodes or other electronic system according to binary combination.

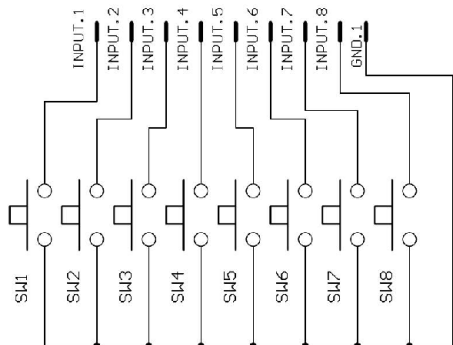

Relation from 8 input to folders name:

- | | |
|------------------|------------------|
| SW1 = Folder 001 | SW5 = Folder 016 |
| SW2 = Folder 002 | SW6 = Folder 032 |
| SW3 = Folder 004 | SW7 = Folder 064 |
| SW4 = Folder 008 | SW8 = Folder 128 |

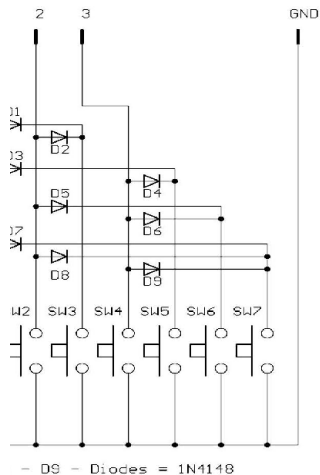

Relation of 3 inputs combination and folder name:

- | | |
|------------------|------------------|
| SW1 = Folder 001 | SW5 = Folder 005 |
| SW2 = Folder 002 | SW6 = Folder 006 |
| SW3 = Folder 003 | SW7 = Folder 007 |
| SW4 = Folder 004 | |

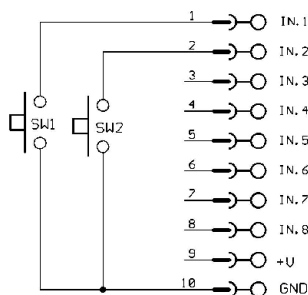

Example to play folder 001 or 002

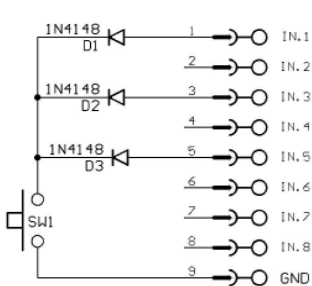

Example of combination to play folder 021

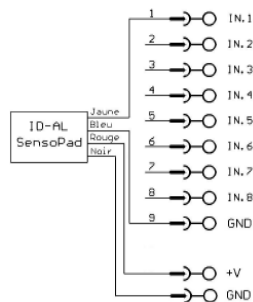

Example for use SensoPad powered by the player to play folder 001

3.3 - Contact output

The VP330 player can control an output contact to switch on/off some peripherals like LEDs, small motors, relays... The output is setup (on/off) by the name of the folder.

The contact output is an electronic switch named «MOSFET». (see schematic). You can control up to 60V / 500mA max device. You can't control device with high power. In this case, you need to use a relay.

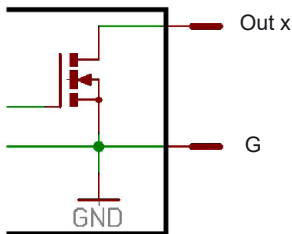

Output schematic

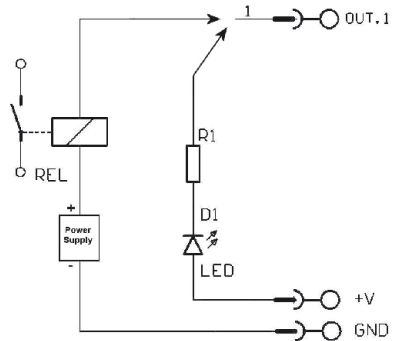

Example of a connection to control a LED in direct or a relay with an external power supply.

Note: +V is a transfer of the main external PSU. The provided power will not exceed 500mA.

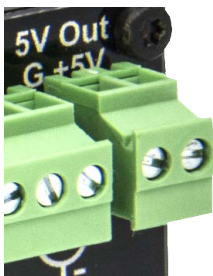
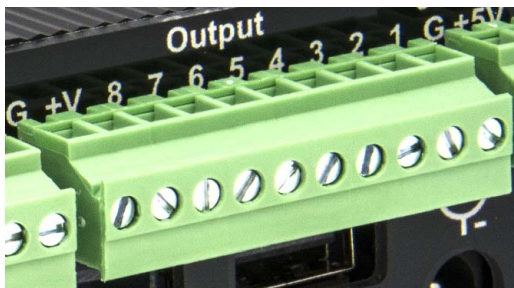

You can use the 5V output to power an external peripheral. Max 1A.

4 - Operating mode

See in annex at the end of this manual, the compatible files.

The name of the files and folders define the playback mode. The files and folders must be stored and copied according to a specific organisation described below.

4.1 Organisation of folders:

Only ONE folder level is allowed at the root. The folder naming is composed of 3 digits (000 to 999) followed by optional parameters and the name of your choice.

You should not use special or accentuated characters.

Example :

001

003 [J002]

034 folder name

127 [SEQ][J001] my folder

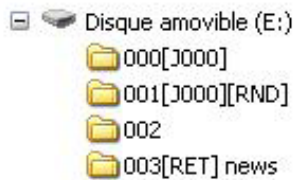

Configuration folder: SYSTEM

SYSTEM folder is used for optional configuration files. See next chapter.

● The first three digits represent the folder number and therefore its main name

Folders are numbered from 000 to 999.

Example :

000 : Folder N°000 - «Autoplay» folder which is automatically played when the device is powered on.

001 : Folder N° 1 - Triggerable by the contact input 1

034 : Folder N° 34

The folder number is used identifies the folder to use during a jump or an input triggering. You can use any number between 000 & 999.

IMPORTANT : The trigger contact input select folder to be played

See at the end of chapter 4 the details of the use.

Special case: Folder 000 is the folder which will be played by default when powering on. When powering on, presence of this folder is checked ; if it is present, the player plays files of this folder.

If this folder is missing, the player is in stop mode.

Additional Parameters - Optional Tags:

To modify the conduct of the player, you can add optional parameters within the folder name. These parameters are boxed with the symbols «[« »]». You can add several parameters within the folder name.

[Jxxx] - Jump to another folder after reading the current folder.

[RET] - Returns to the previous folder after reading the current folder.

[RND] ou [SEQ] - Specifies random or sequential playback mode for the current folder.

[V+xx] [V-xx] - Modify the volume of the player during the playback of the selected folder

[NT] - Define interruption modes.

[WHL] - Play the folder while the assigned input combination remains activated.

[NXTxxx] - Play a specific number of audio files from the folder.

VP330 only:

[RESxxxxxxxx] et [REExxxxxxxx] - Active or deactivate the outputs contacts when play folder or at the end

Note: If no optional parameter has been indicated, the player reads in sequential the folder in full and then stops. The folder can be interrupted

● [Jxxx] - Jump to the Folder xxx at the End of the Playback of the Folder

This tag defines the behavior at the end of the playback of the folder. It indicates the 3-digit number (xxx from 000 to 999) of the next folder to play, which can also be the number of the folder itself in order to play it in a loop. By default, if this tag is missing, the playback stops at the end of the folder.

Example :

001 [J002] Jump to folder 002 after playing folder 001.

003 [J003] Jump to folder 003 after playing folder 003 -> create a loop of the 003 folder.

008 [J023] Jump to folder 023 after playing folder 008.

458 [J999] Jump to folder 999 after playing folder 458.

To play in a loop some audio files on startup, the folder 000 must be used and tagged with [J000]

● [LOOP] - Play the folder in loop without the options at each loop.

With the [Jxxx] option, the other options in the name of the folder are executed at each loop. With the [LOOP] option, the other options are not executed. You can use this function to send RS-232 commands or switch on/off a light when the folder is played or when jump ti other folder and not at each loop.

Example : 001[LOOP]

● [RESUME] - Save the reading position of the files when returning to the folder.

When you jump into a folder, the playlist is reset. If you want to return at the previous position with no reset, place [RESUME] in the name of the folder to save the information.

Example : 001[RESUME]

● [RET] - Return to the Previous Folder at the End of the Playback of the Folder

During the playback of a folder, if an event or a tag instructs to play another folder tagged with [RET], then the player jumps to the new folder. At the end of the playback of this new folder, the player jumps back to the initial folder.

This function can be used to resume the playback of a folder interrupted by the playback of a message triggered by an event.

Example:

001 [J100]	After the folder 001 playback, jump to the folder 100.
002 [J100]	After the folder 002 playback, jump to the folder 100.
100 [RET]	After the folder 100 playback, return to the previous folder (001 or 002).

In the above example, after the playback of the folder 001 or 002, the folder 100 is played, then the player jumps back to the initial folder (001 or 002).

Note: The [RET] tag has only one level of return, i.e. the target folder is always the previously played folder, whatever the number of folders tagged with [RET] played in a row.

● [SEQ] or [RND] - Sequential or Random Playback Mode

By default, without this parameter, the folder is played in random mode.

[SEQ]: playback the files of the folder, in alphanumerical ascending order (see the chapter Organization of the Files inside the Folders).

[RND]: playback in a random order.

Example:

001[SEQ]	Play the folder 001 in sequential mode, then stop.
002[RND][J002]	Play the folder 002 in random mode and in a loop.
003[J001]	Play the folder 003 in random mode, then jump to the folder 001.

● [Vxxx] - Volume setting

The name of the folder have an effect on the output volume. This function is used to broadcast messages loud more or less than others files.

Exemple :

001 [V5]	: Volume is set at 5 from 100 steps (00 to 100)
001 [V100]	: Volume is set at 100, maximum value
001 [V00]	: Volume is set at 00, minimum value (Mute)

- If the variation of values exceeds the minimum or maximum values of the player, the levels are settled to their maximum or minimum.

● [V+xx] [V-xx] - Relative Volume of the Folder

This function can be used to play folders (e.g. containing messages) more or less loud than the other folders.

The xx parameter of the tag is the volume of the folder relatively to the main volume against the selected setting value. It is expressed in volume steps.

Example

001 [V+05] Increase the volume level by 5 steps during the folder playback.
001 [V-03] Decrease the volume level by 3 steps during the folder playback.

At the end of the playback of the folder, the volume level goes back to its previous level.

Note: If the resulting volume is out of the allowed volume range of the player, then it is limited to the minimum or maximum value.

● **[NT]** - Disable the Command Events during the Playback of the Folder

The playback of the folders with this tag cannot be interrupted, and it ignores the instructions received from Input contact, RS-232, TCP/IP, Scheduler...

Example:

001[NT] : The instructions received are ignored during the playback of the folder 001.

However, you can activate some external command manually in the menu if necessary.

● **[WHL]** - Play the Folder while the Assigned Input Combination Remains Activated

This tag allows to play the contents of a folder as long as the corresponding input combination is activated. When the input combination associated with the folder is deactivated, the player applies the folder exit tags. As long as the corresponding input combination is activated, the folder is played in a loop.

001[WHL] The folder 001 is played in a loop while the input combination 1 is activated. When the input combination 1 is deactivated, the player stops.
002[WHL][J045] The folder 002 is played in a loop while the input combination 2 is activated. When the input combination 2 is deactivated, the player plays the folder 045.
003[WHL][J999] The folder 003 is played in a loop while the input combination 3 is activated (inputs 1 and 2 activated). When the input combination 3 is deactivated (inputs 1 and 2 deactivated), the player plays the folder 999.

The dry contact inputs of the player are combinatorial. Therefore, any changes of the input combination are taken into account at any time by the player.

000[J000] The folder 000 is played in a loop on startup.
001[WHL][J000] The folder 001 is played in a loop while the input combination 1 is activated.
002[WHL][J000] The folder 002 is played in a loop while the input combination 2 is activated
003[WHL][J000] The folder 003 is played in a loop while the input combination 3 is activated (inputs 1 and 2 activated). If the input 1 is released, the player plays the folder 002. But, if the input 2 is released, the player plays the folder 001.

● **[NXTxxx]** - Play the Next xxx Audio Files each Time the Folder is Played

This setting allows to play xxx audio files contained in the folder. Once xxx files have been played, the player applies the folder exit tags. If the number of files requested by this tag is greater than the number of audio files contained in the folder, the player loops in the folder as long as needed in order to play the

exact number of audio files requested.

With this tag, the player memorizes the played audio files, meaning that the audio files already played during a previous passing in the folder are not replayed while not all the audio files of the folder have been played.

The xxx parameter of the tag [NXTxxx] is the number of audio files to play in the folder. It is always written with 3 digits (e.g.: 001, 045, 999). It is between 001 and 999.

Example:

001[NXT003]	3 audio files are played in the folder 001, then the player stops.
002[NXT001][J000]	1 audio file is played in the folder 002, then the player plays the folder 000.
004[NXT002][SEQ][J000]	The next 2 files according to the file numbering are played in the folder 004 then the player plays the folder 000.

VP330 only

● **[RESxxxxxxxx]** et **[REExxxxxxxx]** - Active or deactivate the outputs contacts when play folder or at the end

The output contact is switched on/off by the name of the folder when player start to play the folder [RESxxxxxxxx] or at the end of the folder [REExxxxxxxx].

[RESxxxxxxxx] : x is the state of the output when start to play the folder. 0 = off / 1 = on

[REExxxxxxxx] : x is the state of the output at the end of the folder. 0 = off / 1 = on

With those 2 options, you can swith on a lamp during the audio file and swith off at the end.

x is the state of the output :

If x = 0, the output is switched off, no contact.

If x = 1, the output is switched on, a contact is made from output to the ground (GND)

Example :

001[RES0001111]	4 output are switched on when start to play the folder 001
002[REE00110001]	3 output are switched on at the end of the folder 002
003[REE00000001][REE00000000]	1 output is switched on when start to play the folder 003 and it's switched off at the end of the folder

● [RSSxxx] ou [RSExxx] - Send Bytes onto the RS-232 Output

When the folder is called, a list of bytes is transferred by the serial link in order to control other devices (another player, switching grid, projector, ..) The bytes to send are included in a text file that will be especially created for.

Value by default : 19200 Bauds - 8 bits – no parity – 1 bit start – 1 bit stop

You can modify the baudrate manually in the menu.

The file definition of the bytes to send must be named : **serial.txt**

This file will be **copied in the SYSTEM folder** of the media (memory card/flash drive)

[RSSxxx]: xxx appoint the number of the line of the file serial.txt that must be sent (value from 001 up to 999) when player starts to play the folder

[RSExxx] : xxx appoint the number of the line of the file serial.txt that must be sent (value from 001 up to 999) at the end of the folder

The «serial.txt» file is a text file (raw text without page setting) that can be created with any easy text editor like « notepad » from windows or similar. When recording, use «ANSI» coding . Do not use special characters.

The file «serial.txt» of RS232 codes is a text file containing one or several lines. Each of these lines will include a sequence of bytes expressed in hexadecimal and separated by a space (from 00h to FFh). You must only indicate the two characters of the wished hexadecimal value.

Each beginning of line of this file should present the following parameter:

#xxx : the xxx number of the line containing the bytes to send related to the xxx of the tag.

[RSS002]-> line #002 – the tag [RSS002] will send the sequence of bytes of the line #002 of the serial.txt file.

The separator between each byte is a space.

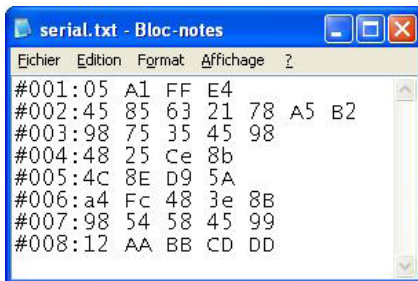

Example of a line contained in the serial.txt file.

```
#001: 45 85 63 21 78 A5 B2
#002: 98 75 21 35 45 98
#100: 21 35 45 78 A5 B2
```

It is also possible to add comments in the file by using two times the type «/» (slash) = //

```
// example file
#001: 05 A1 FF E4 // comment in the line
#005: 45 85 63 21 78 A5 B2
#100: 98 75 35 45 98 // my command
//other command
#064: 48 25 Ce 8b
#128: 4C 8E D9 5A //
#999: a4 Fc 48 3e 8B
// comments at the end of the file
```

An example to allow the triggering of the reading of the folder 001 for another VP250HD.

```
#001: 80 01 01
```

Example of tag:

001[RSS001][RSE002] : Sending of the bytes of the line #001 of the file serial.txt on reading of the folder 001 and sending the bytes for the line #002 of the file serial.txt at the end of the folder.

001[RSS001]: Sending of the bytes for the line #001 of the file serial.txt on reading of the folder 001

002[RSE064]: Sending of the bytes for the line #064 of the file serial.txt at the end of the folder 002

● Specific conduct:

If a folder is missing but a command designates this folder, the command is ignored.

● SYSTEM folder - This folder contains the configuration files

This folder is optional. It will be used to offer some extended functions.

SYSTEM\serial.txt -> File with the bytes to send by RS232 with the option [RSSxxx] and [RSExxx]

SYSTEM\scheduler.tm2 -> File for the scheduler

4.2 5.2 Organization of the Files inside the Folders

Like for the folders, the filenames define the behavior of the playback.

Note: The naming of the files is free if the playback is in random mode. ([RND] option or no option in the folder name). In this case, all the files are played and can be interrupted.

In sequential mode, the files are played in alphanumerical order. Playback options (tags) can be added as needed, like a blocking of commands or a temporary change of the volume.

[Jxxx] - Jump to another folder after reading the current folder.

[RET] - Returns to the previous folder after reading the current folder.

[Vxxx] - Controls the volume level of the folder

[V+xxx] [V-xxx] - Modify the volume of the player during the playback of the selected folder

[WHL] - Play the folder while the assigned input combination remains activated.

[NXTxxx] - Play a specific number of audio files from the folder.

[SYNCHRO] - Permet de synchroniser les lecteurs entre eux pour démarrer la lecture en même temps

VP330 only:

[RSSxxx] or **[RSExxx]** - Sending of RS232 codes at the beginning or at the end of the folder

[RESxxxxxxxx] et **[REExxxxxxxx]** - Active or deactivate the outputs contacts when play folder or at the end

The options are similar than the folder uses but for the files. See previous chapter.

● [SYNCHROxxx] - Synchronize players to play simultaneously

The VP3x0 models support synchronization over Ethernet. You can synchronize a group of players and support many group on the same network.

Each player could be «Master» and send command to the «Slave» or «Slave» and receive a command. A player become a master when it play a file with the tag [SYNCHROxxx] in its name. xxx is the name of file to play in the slaves players. Then you can synchronize at any moment or any context the players on the network.

A group is created by the value of the Ethernet port. By default the port is 44830. You can change the value then the group manually in the menu. All players with the same port will be in the the same group.

Master :

Create the folders as normal operation. Inside the folder, select the file which will send the synchronisation commande and add the tag [SYNCHROxxx].

Example :

001[J000]

 Bird1 [SYNCHRO001].mp4

 Cat.mp3

 Dog [SYNCHRO002].mov

Files with tag [SYNCHRO] will send a command on the network. If other players are connected on the network with the same port, they will play the selected file.

Slave:

Create a folder at root with the name «synchro». In this folder, place the files to play with a number in the file name.

Example :

synchro

 001 Bird2.mp4

 002 [J001] Dog2.mov

4.3 Contact input

Contact input are used to play folders designated by the number of the activated entry. The VP330 has 1 separate input and 8 additional inputs.

The separate input is configurable in the menu and plays the 001 folder by default.

The 8 entries of the VP330 play the first 255 folders in a binary order.

Folder No. 001 is triggered by the separate input or input 1 of the group of 8 inputs.

The 8 input contacts are used to play the file numbers corresponding to the 3 digits of the file number following a binary order from 001 to 255. (see table in the appendices)

Entry 1: File 001

Entry 2: File 002

Entry 3: File 004

Entry 4: File 008

Entry 5: File 016

Entry 6: File 032

Entry 7: File 064

Entry 8: Folder 128

Simultaneous pressing of multiple input contacts offers up to 255 different combinations. Nos. 001 to 255 correspond to the combinations of the 8 input contacts.

Example to play the folders from the block of 8 entries:

001: activation of entry $N^{\circ} 1$

002: activation of entry $N^{\circ} 2$

003: activation of entries $N^{\circ} 1 + N^{\circ} 2$

004: activation of entry $N^{\circ} 3$

005: activation of entries $N^{\circ} 3 + N^{\circ} 1$

006: activation of entries $N^{\circ} 3 + N^{\circ} 2$

007: activation of entry $N^{\circ} 3 + N^{\circ} 2 + N^{\circ} 1$

008: activation of entry $N^{\circ} 4$

009: activation of entries $N^{\circ} 4 + N^{\circ} 1$

and so on following a binary progression. (see table in annex)

Note: You can also trigger folders via the RS-232 serial link of the player. To do this, please refer to the RS-232 serial link chapter.

5 - Control with a Timestamped Programming (Scheduler)

5.1 Introduction

The VP3x0 can be controlled thanks to a timestamped programming. This feature, named Scheduler, allows to timetable the playback of audio files (messages, spots, musics, sounds) and to stop or resume the playback on accurate date and time.

5.2 Principle

The VP3x0 uses its built-in clock to perform scheduled actions. These actions are stored in a timestamped programming file named the Scheduler file.

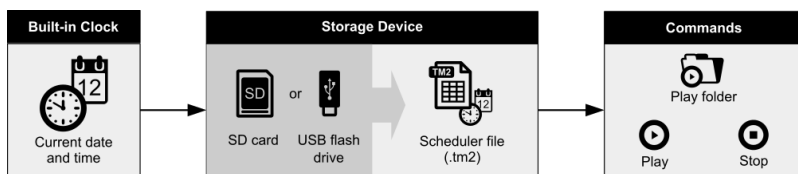

First, create a «Day template», (Monday, Saturday, Closed day, Special offer day...) where you will place the actions during the day (message, other folder, awake mode...). Then place the day template in the calendar and export the scheduler file to be copied on the media.

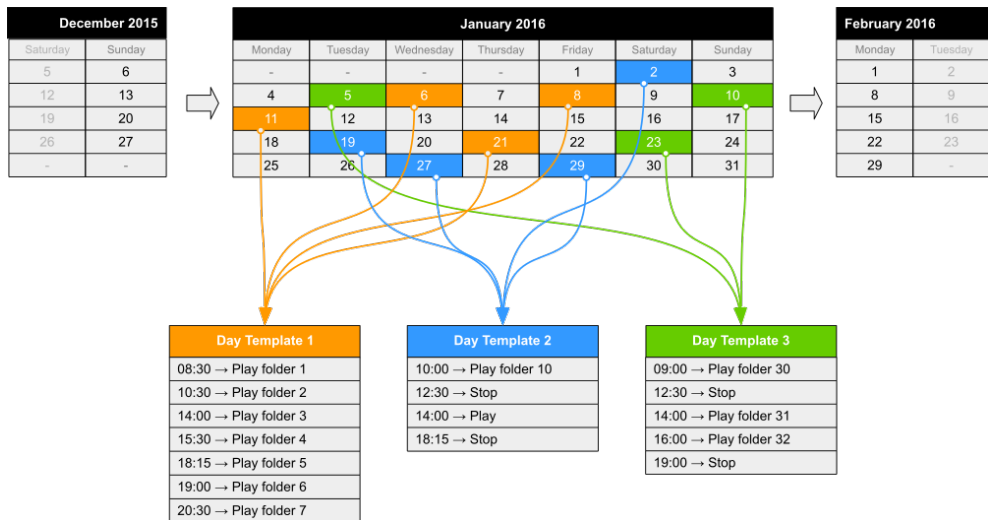

Notes :

- The dates requiring no actions are left empty and do not refer to any day template.
- If several dates require the exact same set of actions, then the calendar can refer to the same day template for these dates.

A day template contains all the events of a full day, for every minute, from 00:00 till 23:59. These events describe the command (action) to execute and when (precise time).

With the Scheduler feature:

- A schedule can contain up to 65535 different day templates.
- Within a day template, a different command can be scheduled for each minute.
- An action takes place precisely upon minute change.
- An event can execute a one-time command.

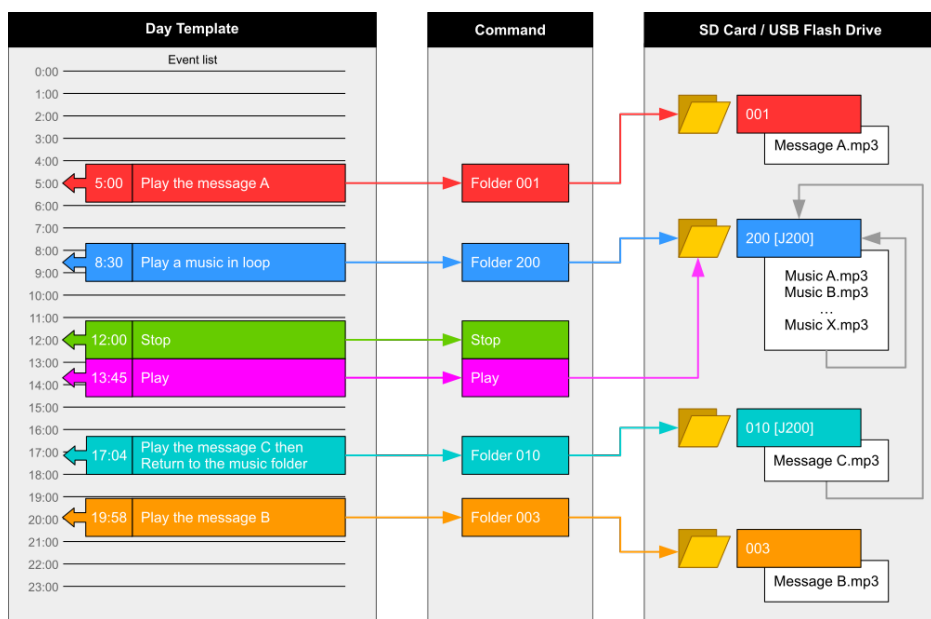

The following commands can be attached to an event:

PLAY FOLDER: launch the playback of a folder containing audio files (up to 1000 folders supported). This command requires the number of the folder to play (3 first digits between 000 and 999). The folder has to be stored in the root folder of the storage device. The way a folder is played depends on the tags appended to its name (loop: xxx[Jxxx], random: xxx[RND], sequential: xxx[SEQ]) (see the chapters Organization of the Folders).

PLAY: launch the playback of the folder in which the player stopped. If no folder playback action predates this command, or if the player stopped because out of a folder, this action is ignored.

STOP: stop the playback within the folder being played.

Un événement peut effectuer les commandes suivantes:

5.3 Creation of a Timestamped Programming File

The timestamped programming is stored in a Scheduler file. This file is generated by the Scheduler software developed for this purpose. Please check our website for additional information (www.id-al.com). The files generated by the Scheduler software are TM2 files with the .tm2 extension.

The file must be named: scheduler.tm2 and copied in the SYSTEM folder of the media.

**Scheduler software and complete manual could be downloaded
for free from the web site www.id-al.com**

6 - RS232 serial link protocol

The VP330 can communicate with other devices by receiving instructions onto the Rx input or transferring data through its Tx output. The player complies with the RS232 norm (see annex for features).

Value by default: 19200 Bauds - 8 bits - no parity - 1 bit start - 1 bit stop

You can change the baudrate manually in the menu.

5.2 - Reception Protocol

With the input protocol, the player can receive instructions to launch a folder playback or sets the volume control. On the other hand, in a framework of using several players on the same link, the player answers to its own number (defined in the file config.txt, see chapter related) or to a general command

The reception protocol is made of a 3 bytes frame.

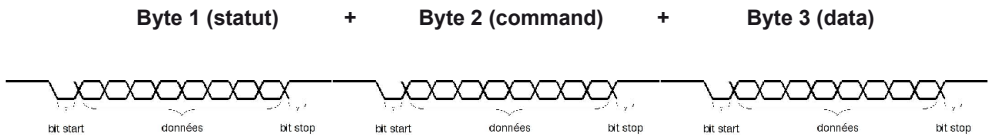

Reminder:

- a byte is composed of 8 bits: b7 b6 b5 b3 b2 b1 b0
- a binary representation is noted: 10000000b or in hexadecimal : 80h

Byte 1 : Status - 1xxxxxxx

The byte status is a synchronization information of frame. Its Byte 8 (b7) is always at 1. All others bytes (commands or datas) have their byte 8 to 0.

b7 = 1: refer to a status byte

b6 - b0: identification of the player to be addressed from 001 to 127 (000001b - 1111111b)

- The address of the player is by default (ID) 001. You can modify it in the configuration file.
- Several players may have the same identification number to create groups.
- Identification 000 is the «overall» code, all players are concerned by the command (unique command for all the players).

Example:

80h = «overall» code for all the players

81h = player n°001

9Eh = player n° 030

FFh = player n°127

Byte 2 (Command) 0xxxxxxx + Byte 3 (Data) 0xxxxxxx

The Byte 2 is a command and the byte 3 is a data that completes the command byte. A command byte is always followed by a byte of data. A full frame is therefore made of 3 bytes.

b7 = 0 : refer to a byte of command or data

b6, b5, b4, b3, b2, b1, b0 : command code sent to the player

List of commands:

00h: not used

01h/11h/21h/31h/41h/51h/61h/71h: command of a jump into a folder

02h: transport bar command

03h: volume control command

04h : Request informations

05h/06h : Reserved

07h à 7Eh : Not used

7Fh : Identification number change (ID)

● **00h - 0000000b: not used**

● **01h to 71h - 0xxx0001b : command of a jump into a folder**

The folder is designated by the bank number and the following data byte.

xxx is the bank number. In order to be able to launch 1000 folders (from 000 to 999), it is necessary to divide this number into several folder ranges (banks) of 128 values.

0xxx0001b: xxx = bank number depending on the folder number

01h - 00000001b : Bank 0 -> from 000 to 127

11h - 00010001b : Bank 1 -> from 128 to 255

21h - 00100001b : Bank 2 -> from 256 to 383

31h - 00110001b : Bank 3 -> from 384 to 511

41h - 01000001b : Bank 4 -> from 512 to 639

51h - 01010001b : Bank 5 -> from 640 to 767

61h - 01100001b : Bank 6 -> from 768 to 895

71h - 01110001b : Bank 7 -> from 896 to 999 (other value over 999 are ignored)

Method of calculation:

Bank = value in the above table depending on the folder number.

Value = folder number - (bank number x 128).

Example of a frame launching the folder 278 for the player number 001:

Folder number = 278

278 is in bank 2 (from 256 to 383).

Value = 278 - (2 x 128) = 22 = 16h.

For this example, the complete hexadecimal frame is: 81h 21h 16h.

● **02h - 00000010b: Transport bar command**

The transport function is defined by the data byte as follows:

Value of the datas of the byte 3 (datas)

01h - 00000001b : Playback

02h - 00000010b: Stop

03h - 00000011b: Next file in the current directory

04h - 00000100b: Previous file in the current directory

05h - 0000101b : Pause / Play
06h - 0000110b : Play next folder
07h - 0000111b : Play previous folder
08h : 00001000b : Stand by / Wake up
09h: 00001001b: Increases the volume by +1 step
0Ah: 00001010b: Decrease the volume by -1 step
0Bh: 00001011b: Not used
0Ch: 00001100b: Stand by
0Dh: 00001101b: Wake up
0Eh: 00001110b: Pause
0Fh: 00001111b: Resumes playback after a pause
10h: 00010000b: Mute or Unmute the sound of the audio output
11h: 00010001b: Mute the sound of the audio output
12h: 00010010b: Unmute the audio output to its previous level

Note: the other values are ignored.

Example of the complete frame to stop the player : 81 02 02
Byte 1 : 10000001b (81h) : Status byte, player ID 001
Byte 2 : 02h - 00100001b : Transport bar command
Byte 3 : 02h - 00010110b : Stop command

Note: Other values are ignored

● 03h - 00000011b : Volume control command

The value of the volume is defined by the data byte as follows:

00h - 00000000b : mute - volume at 0
10h - 00010000b : half volume - value 50
1Fh - 00011111b : maximum volume - value 100

Note : the others values are ignored

Example of the full frame : 81 03 0E
Byte1 : 81h - 10000001b : status byte, player number 001
Byte2 : 03h - 00000011b : volume command
Byte3 : 0Eh - 00001110b : volume setting at 14

● 04h - 00000100b : Request informations

An external peripheral device can ask the player to render informations like status (Play, stop), current file/folder, remaining time...

Value of the data byte:

01h - 00000001b : Player status du lecteur -> PLAYING / STOP / PAUSE / ERROR
02h - 00000010b : Current file name -> example : bird.mp4 - If stop mode, the last file played
03h - 00000011b : Complete path folder/file name- Exemple : Example : 001/bird.mp4
04h - 00000100b : Media used -> USB / SD / Internal memory
05h - 00000101b : Not used

06h - 0000110b : Folder number -> 001 to 999 - Example : 005
07h - 0000111b : Not used
08h - 00001000b : Not used
09h - 00001001b : Remaining time -> hh:mm:ss - Example : 00:05:14
0Ah - 00001010b : Total time of the file : hh:mm:ss - Example : 01:42:27
0Bh - 00001011b : Volume value -> xx (00 to 100) - Example : 16

When the player receives a request command, it sends the information in ASCII mode on the Tx pin of the RS232 link.

Example1:

Frame to send to the player to request status: 81 04 01
Byte1 : 81h - 10000001b : status byte, player number 001
Byte 2 : 04h - 00000100b : Request informations
Byte 3 : 01h - 00000001b : Request status

Player send : PLAY + CR/LF -> in ASCII -> 50 4C 41 59 0D 0A (Value in Hexa)

Example 2:

Frame to send to the player to request remaining time : 81 04 09
Byte1 : 81h - 10000001b : status byte, player number 001
Byte 2 : 04h - 00000100b : Request informations
Byte 3 : 09h - 00001001b : Request remaining time

Player render: 00:03:12 + CR/LF -> in ASCII = 30 30 3A 30 33 3A 31 32 0D 0A (Value in Hexa)

● 05h - 00000101b : Reserved

● 06h à 7Eh : Not used

● 7Fh - 01111111b : Command in order to change the identification number of the player (ID)

You can change the ID (Identification number) of the player for the RS232 link. The default value is 001. You can change value from 001 to 127. The data byte defines the number of the new ID.

Example of a complete frame to change ID to 002: 81 7F 02
Byte1 : 81h - 10000001b : status byte, player number 001
Byte 2 : 7Fh - 01111111b : ID change command
Byte 3 : 02h - 00000010b : ID N° 002

7 - Ethernet

Via the Ethernet link, the VP3x0 communicates either to update content via FTP (SD card, USB flash memory, internal memory).

You can use the player in a local network. An adequately configured Modem/Router will allow update the player via the Internet.

Caution! Network administration requires good computer skills.

In a local network installation, the player requires an IP address. This address is set in the Option menu (see option menu chapter). The player is then recognized on the network as a FTP server with a FTP software such as «Filezilla».

In an installation where only the player is present or in a local network with external access, you must use a Modem/Router to create a gateway between the player and the Internet.

Since the Modem/Router is configured with an IP gateway, you must declare this gateway to the VP3x0 so it can communicate outside (to be configured in the Option menu).

Note: The VP3x0 offers a DHCP mode by default to get an IP address automatically. When the player is connected in FTP mode, the player is in stop mode and can't play anything.

Host: IP adress
Default User: : idalftp
Default password: idalftp

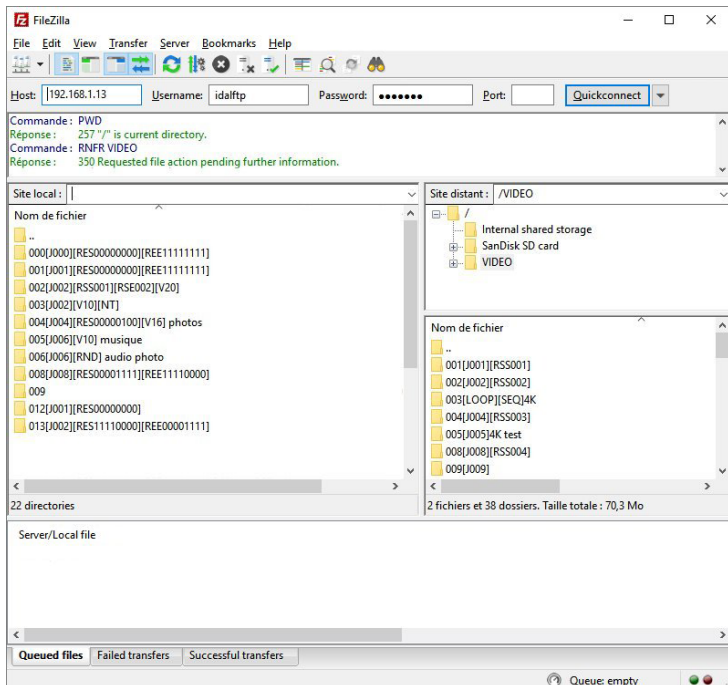

You can change manually the user / password in the menu.

8 - Menu

To configure the player settings, press the «MENU» button on the remote control.

You can then navigate through the different menus with the arrows on the remote control to change the setting you want. OK to validate, ESC to cancel. MENU to exit the menu.

Main menu: Main menu displayed when you press the button on the remote control

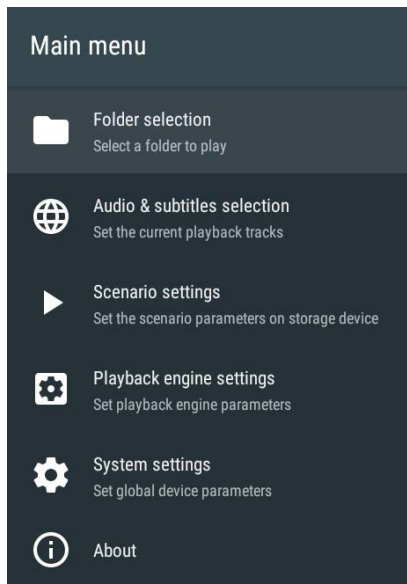

Folder selection: To see the media content and play manually the folders

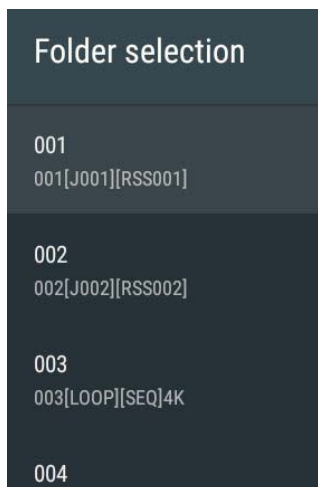

Audio & Subtitle selection : Display audio characteristics and subtitles.

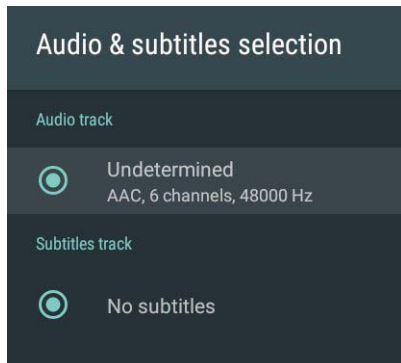

Scenario settings: Allow to modify the behavior of the player

 **Be careful changing these parameters creates a file on the media «scenario.json» in the SYSTEM folder. If this file is manually removed from the media, these configurations will be lost.**

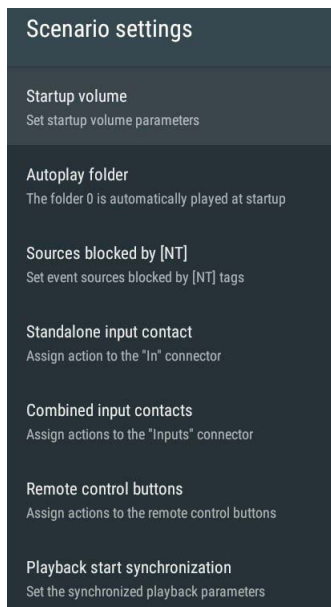

Playback engine settings: Allows you to configure basic playback settings such as the media to use, the duration of slideshow images, and various other settings.

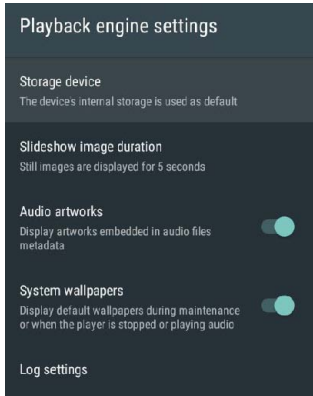

System settings: General configuration menu of the player (network, screen, date / time ...)

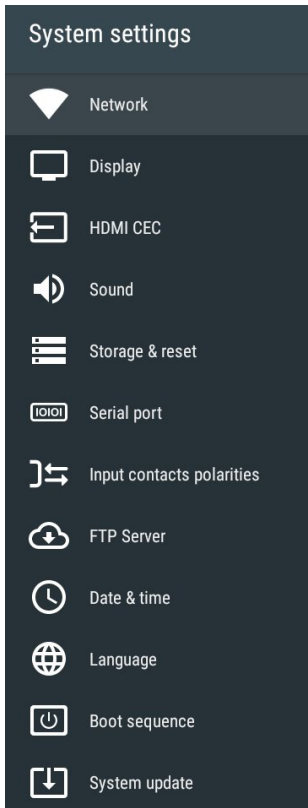

About : Informations about the player



Annexe A - Caractéristiques

Interface et connectique

- LED status indicator
- Clickable knob (volume)
- Infrared sensor - Protocol: NEC
- HDMI Type-A (standard) receptacle connector (HDMI 2.0b, HDR10 and CEC and HDCP v2.2)
- 2 USB Host 2.0 High Speed (480Mb/s), type-A receptacles
- microSD card slot
- 0 dBu unbalanced line-level stereo audio output on standard RCA connectors
- 10/100 Mbps Ethernet, RJ45 connector
- Headphone stereo audio output on a standard 3.5mm (TRS) jack
- Class D amplified speaker stereo audio output on 3.81mm pluggable terminal blocks
- Configurable opto-isolated input on a 3.81mm pluggable terminal block
- Power supply output on a pluggable terminal block
- External DC power supply chassis socket – Plug Ø 2.1mm / 5.5mm

VP330 only:

- 8 configurable opto-isolated inputs on a 3.81 mm pluggable terminal block
- 8 MOSFET outputs (500mA per output, max 20V) on a 3.81 mm pluggable terminal block
- RS-232 serial link on a 3.81 mm pluggable terminal block (9600, 19200, 38400, 57600, or 115200 bauds)
- 3 additional power supply outputs dispatched on the pluggable terminal blocks
- 5 V DC - 500mA output on a pluggable terminal block

Output Video Formats Supported

- 4K Ultra HD (3840 × 2160), 24/25/30/50/60 Hz
- 1080p (1920 × 1080), 24/50/60 Hz
- 1080i (1920 × 1080), 50/60 Hz
- 720p (1280 × 720), 50/60 Hz
- 576p and 576i (720 × 576), 50 Hz
- 480p and 480i (720 × 480), 60 Hz
- Dynamic range: HDR10 compatible

Multimedia Container Formats Supported

Video:

- .mp4 (MPEG-4)
- .mkv (Matroska)
- .mov (QuickTime)

Picture:

- .jpg or .jpeg (Joint Photographic Experts Group) (ISO/IEC-10918)
- .png (Portable Network Graphics)
- .bmp (Bitmap)

Audio:

- .wav (WAV)
- .mp3 (MPEG-Layer 3)
- .m4a (MPEG-4 Audio)
- .ogg (OGG, Opus and Flac)

Multimedia Codecs Supported

Video:

- H.265 HEVC MP-10@L5.1 up to 4K×2K@60fps
- VP9 Profile-2 up to 4K×2K@60fps
- H.264 AVC HP@L5.1 up to 1080p@60fps and 4K×2K@30fps

Picture:

- JPEG unlimited pixel resolution (ISO/IEC-10918)
- PNG unlimited pixel resolution
- BMP unlimited pixel resolution

Audio:

- WAV: mono/stereo, up to 24-bit LPCM@96kHz, WAVE_FORMAT_PCM (WAVE_FORMAT_EXTENSIBLE Format not supported)*
- MP3: MPEG-1/2 Audio Layer III, mono/stereo, 16 bits up to 48kHz@320 kbit/s, CBR (Constant Bit Rate) or VBR (Variable Bit Rate) files, with or without ID3v1/2 tags
- AAC-LC: Advanced Audio Coding, mono/stereo, up to 96kHz@512 kbps.
- HE-AAC-LC: High-Efficiency Advanced Audio Coding, mono/stereo, up to 96kHz@512 kbps.
- Vorbis: mono/stereo, up to 48kHz@350 kbps.

Other File Formats Supported:

- TM2 (.tm2): timestamped programming file (scheduler.tm2) - Scheduler V2 file format

File systems supported:

- FAT32 (read/write)
- exFAT (read/write)
- NTFS (read/write)
- ext2/3/4 (read/write)

Accepted storage device types:

- microSDSC / SDHC cards
- USB flash drives
- Internal storage: 4 GB

Network:

- Embedded FTP server for remote content update
- Embedded NTP client
- IPv4 and IPv6
- IPv4: static or DHCP address
- Embedded mDNS identification service (Zeroconf)
- Multicast "Start Synchro" facilities over UDP

Built-in Clock:

- Timekeeping when the player is not powered: up to 2 months

Audio amplifiers :

Headpone output

Maximum output power:

2 × 15 mW for 32 Ω

2 × 30 mW for 16 Ω

THD+N:

0.014 % for 2 × 5 mW, 32 Ω, 1 kHz

0.016 % for 2 × 10 mW, 32 Ω, 1 kHz

0.022 % for 2 × 10 mW, 16 Ω, 1 kHz

0.028 % for 2 × 20 mW, 16 Ω, 1 kHz

Speaker output:

2 × 8 W - 8 Ω, THD+N = 1 %, 1 kHz

2 × 10 W - 8 Ω, THD+N = 10 %, 1 kHz

2 × 15 W - 4 Ω, THD+N = 1 %, 1 kHz

2 × 19 W - 4 Ω, THD+N = 10 %, 1 kHz

Power supply:

- Nominal voltage: 12 V DC - The player is protected against polarity reversal.

Typical Current Consumption (12 V supplied):

- Playback content on its embedded internal memory, without amplifier: up to 500 mA

- Playback content on a USB flash drive with amplifier: up to 3A

Thermal Information:

- Operating ambient temperature: from 0 to +40 °C

- Storage temperature: from -20 to +60 °C

Dimensions :

- Width: 143 mm - 1/3 of a 19-inch rack

- Height: 44 mm - 1U

- Depth (with terminal block connectors): 140 mm

Weight:

- VP320: 365 g (with the pluggable terminal blocks)

- VP330: 462 g (with the pluggable terminal blocks)

Annexe B - Infra red remote control

You can send command to player using an infra red remote control.

Key	Function
Power	On / Off
Navigation	Arrow up, down, left, right
OK	Validation
Menu	Enter in Menu
ESC	Escape
Vol +	Volume +
Vol -	Volume -
Page +	Next folder
Page -	Previous folder
Play	Play
Stop	Stop
Pause	Pause/Play
Rwd	Rewind
Fwd	Fast forward
Mute	Mute
Red	Configurable key
Green	Configurable key
Yellow	Configurable key
Blue	Configurable key



Annexe D - Accessories

You can use some accessories with your VP3x0 players



Rack support 19" - 1U



15 input extension board for VP330



Mono-earphone



Vibro Pad - Audio transducer for cardboard



Antivandal push button



Senso PAD - Capacitive push button

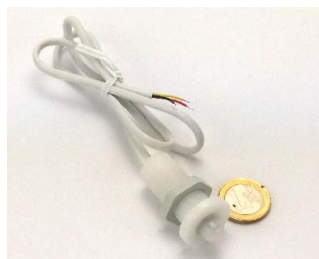

IR PAD - IR motion sensor

Annexe E - Frequently Ask Questions

I don't know how my file is encoded. Which software can I use to know precisely which are the characteristics of my file? (format, type, encoding, bitrate...)

If you have not any software for this, you can use MedialInfo software (<http://mediaarea.net/fr/MedialInfo>). This software, provided under BSD license, is free and opensource on all operating system (Windows, Mac OS X or Linux).

I have not any software to re-encode my video file in a format compatible with my player. Which software do you recommended?

This question is wide, because many encoding softwares exist. It would be simplistic for us to summarize all free and commercial solutions in a single reference. In a first time, refer to your owner's manual to be aware of the formats supported by your player. If you can not find reference encoding software, you can use the Handbrake software (<http://handbrake.fr/>). This software, provided under GPL license, is free and opensource on all operating system (Windows, Mac OS X or Linux). It allows you to encode your video files into H.264 in MP4 contenaire.

I have properly named «000» the autoplay folder, but the player reads the folder just one time, what is the problem?

By default, the folders are not played in loop. The condition to play a folder in loop depend to the add of a specific parameter in the name of the folder. This parameter is a jump function, done when the folder is fully played. To play your folder in loop, please, rename the autoplay folder from «000» to «000 [J000]». For more informations on the folders parameters, please, refer to your owner's manual.

I have created a text file «serial.txt» as specified into the manual, but the player does not include instructions that i put in the configuration file. Why?

Make sure that the «serial.txt» file is generate with a basic text editor like the «Notepad» of Microsoft Windows. Otherwise, your text editor needs to create a «ANSI» file, 100% ASCII. «DOC», «RTF», «»UTF-8», «UTF16», «UNICODE» or other format of text file are exclude.

Information about video formats

A video is a succession of images to which are added sound, titles and subtitles, called «metadata». All these elements are then placed and compressed in a file called «container» identified by its name as mov, mp4, mkv ... The higher the quality of a video, the larger the file created, it is for that we use a CODEC compression algorithm for compression and decompression.

The disadvantage is that during compression the quality of the video may drop depending on the method used. The choice of format is important. Video files use different codecs to encode and compress data. They are not all data formats, for example .mov is a container with no indication of the type of Codec used.

Inside these containers, the files can be compressed with different CODECs. VP3x0 supports H265 / H264 and VP9 codecs.



**Design and manufacturing of interactive
audio and video players**

**Check our products, informations
and technical solutions on our web site:
www.id-al.com**